

C.E. TOOLING

Section 9.4

EHRT BUSBAR PUNCHING MACHINES
Hole Cut 40-6/9-2000, EB30 CNC, EB40 CNC



EHRT TOOLING

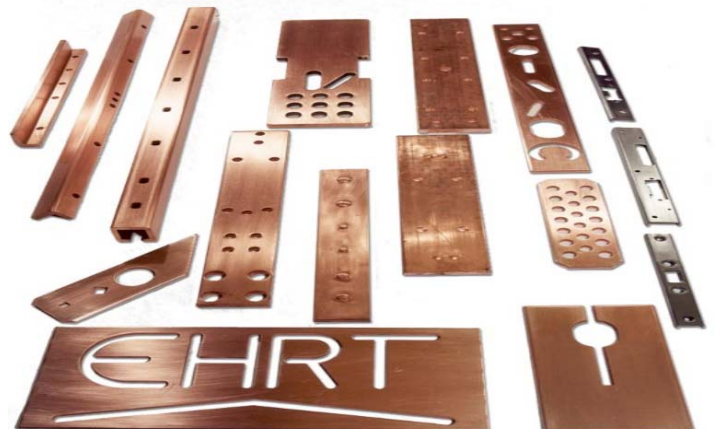
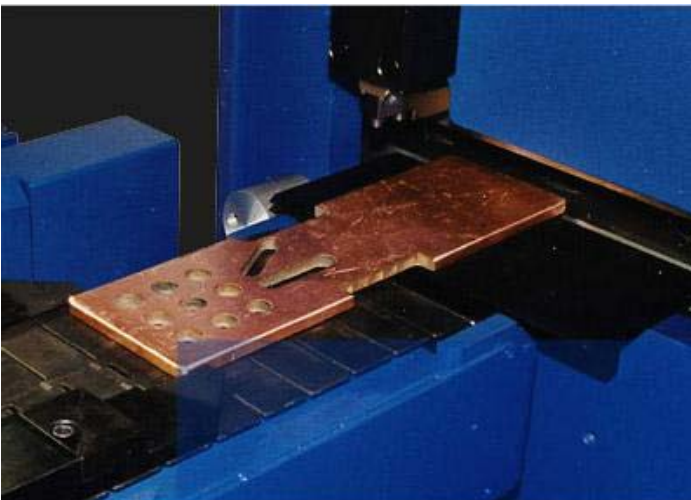

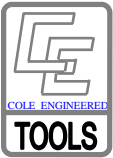

ADDITIONAL COSTS FOR NON-STANDARD OPTIONS

CETooling, started out in 1966 in Chicago as a tool & die shop. In the late 70's we directed our energies exclusively to the manufacturing of tooling for turret, and duplicator presses. Through our use of the highest steel grades, combined with manufacturing processes and procedures developed from over 50 years of producing punches and dies, our quality and value is unbeatable!

Currently CET is supplying all Fabrication: PUNCH, BEND & SHEAR tooling. This is done through our own manufacturing capabilities and relationships we have with other fab tool manufactures.



**RADIUS OR 45°CHAMFER,
Punch Add On, per corner**

	Corners 1-3 # x	4(all)
With Length under 1.625 and any size Radius or Chamfer	# x \$10.00	\$10.00
With Length over 1.625 & .032 maximum Radius or Chamfer	# x \$10.00	\$30.00
With Length over 1.625 and Radius or Chamfer over .032(.8mm)	# x \$15.00	\$40.00
Add On To All Dies any size Radius or Chamfer	# x \$10.00	\$10.00

Add 25% to set price for **Clearance** of .003(.8mm) or less

Add 50% to die price for **Solid Dies.**

10 STANDARD SHAPES

RECTANGLE • SQUARE • OBROUND • SINGLE-D
DOUBLE-D • QUAD-D • HEXAGON • OCTAGON
ADD \$10 PER SET FOR: LONG-D & EQUILATERAL

EXPEDITING SERVICES

1FDS • ORDER BY 3 pm,
Order Ships The Next or same work day — **Add 25%**

2FDS • ORDER BY 3pm,
Order ships in 1-2 work days— **Add 10%**

SPECIAL SHAPES SHIPPED IN 3-10 days



Guaranteed Shipment (Expediting)

3FDS "FIRM DELIVERY SERVICE"
Order By 3pm, to ship in 3 Work Days

5FDS "FIRM DELIVERY SERVICE"
Order by 3pm, to ship in 5 Work Days

Shapes on Angles or Extra Key Locations. Die View

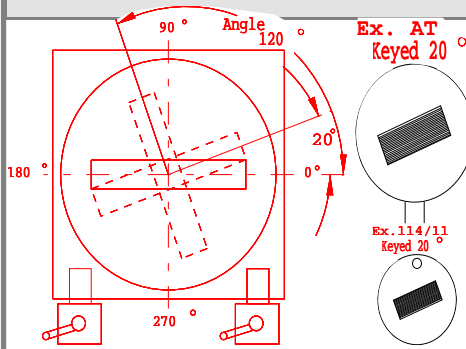

Visualize location key of tool as it would load into turret. Start with length of shape horizontal Length points to 0°
Rotate shape, not location key.
A sketch accompanying your order ensures keying as required!
Note: Other Manufactures ordering diagrams may differ from C.E.'s!

Punch Coatings:
TiN Titanium Nitrite or TiCN Titanium Carbon-



CE TOOLING, INC.

EHRT Punches, Guides and Dies

Pricing is for Punch Tip Sizes .093" (2.3mm) to 1.000" (25.39mm)

EHRT PUNCHES

Mfg. from HIGH SPEED

Punch Body Shank	RANGE DIAGONALLY Tip Sizes of .093(2,3mm) &>	ROUNDS CATALOG CODE	PRICE .093/2,3 &>	SHAPED 10 different shapes	PRICE .093/2,3 &>	
8mm	.093-.315 (2,4-8,0mm)	EH8-Pr		EH8-Ps		
12mm	.093-.4724 (2,4-12,0mm)	EH12-Pr		TR12-Ps		
16mm	.093-.630 (2,4-16,0mm)	EH16-Pr		EH16-Ps		
20mm	.093-.7874" (2,4-20,0mm)	EH20-Pr		EH20-Ps		
25mm	.093-.984" (2,4-25,0mm)	EH25-Pr		EH5-Ps		
32mm	.093-1.260" (2,4-32,0mm)	EH32-Pr		EH32-Ps		
40mm	.093-1.575" (2,4-40,0mm)	EH40-D		EH40-Ps		

Coatings:TiN Titanium Nitrite/TiCN Titanium Carbon-Nitrite/Alpha 1-3 PCS +\$32.00ea 4-9 PC + \$25ea 12+ \$18ea.

EHRT Fitted GUIDES

Mfg. from D2 18% Chrome Tool Steel

	RANGE DIAGONALLY Tip Sizes of .093(2,3mm) &>	ROUNDS CATALOG CODE	PRICE .093/2,3 &>	SHAPED 10 different shapes	PRICE .093/2,3 &>	45mm dia. X 16mm thick 6mm dowel location pin
	.093-1.654 (2,4-42,0mm)	EH-Gr		EH-Gs		

EHRT DIE

Mfg. from D2 18% Chrome Tool Steel

	RANGE DIAGONALLY Tip Sizes of .093(2,3mm) &>	ROUNDS CATALOG CODE	PRICE .093/2,3 &>	SHAPED 10 different shapes	PRICE .093/2,3 &>	60mm dia. X 20,5mm thick Key 12w X 6d
2mm land, then 2° slug relief	.093-1.654 (2,4-42,0mm)	EH-Dr		EH8-Ss		



Shape Die and Guides are keyed @ 0° for 0 & 90°. Extra Keys + \$65.00, any

FABRICATING TOOLS
and Accessories for most
Punching, Bending and
Shearing Equipment

C.E. TOOLING, INC.

FORMING AROUND THE WORLD

MANUFACTURING TURRET PRESS TOOLING SINCE 1966

www.cetooling.com

C.E. TOOLING, INC.

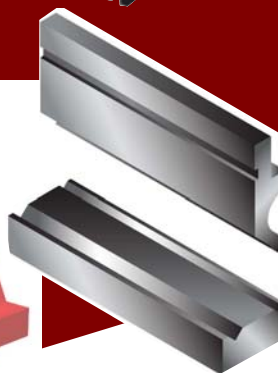
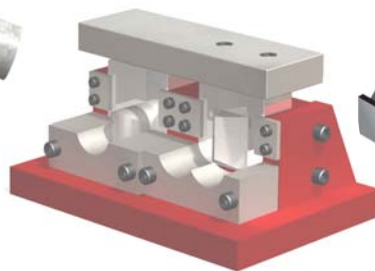
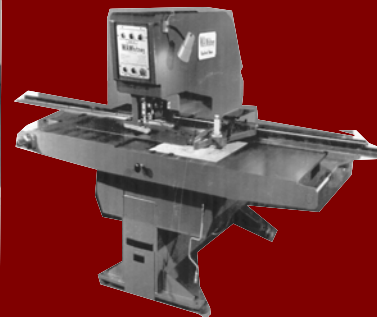

CETOOLING FACTORY
2560 W. Brooks Ave.
N. Las Vegas NV 89032

sales@CEtooling.com

Tel. 702 736-2958

www.CEtooling.com

Fax 702 736-3038



LOCAL SALES REPRESENTATIVE
DISTRIBUTORS